

Sungrow Power Supply Co., Ltd.

Add: No. 1699 Xiyu Rd., New & High Technology Industrial Development Zone, 230089, Hefei, P. R. China.
Web: www.sungrowpower.com

E-mail: info@sungrow.cn



More information in the QR code or
at <http://support.sungrowpower.com/>

SUNGROW

Specifications are subject to changes without advance notice.

Quick Installation Guide

DTSD1352-C

Three-phase Energy Meter

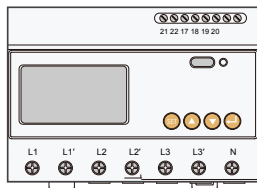

Applicability

This manual is applicable to three-phase Energy Meter.

- DTSD1352-C/10(80)A
- DTSD1352-C/1(6)A

Keep the manual in a convenient place for future reference. The latest manual can be obtained at www.sungrowpower.com.

Target Group

Only qualified personnel with the following skills are allowed to perform the work described in this document:

- Training in the installation and commissioning of the electrical system;
- Capable of coping with the dangerous and emergency situations during the installation and commissioning;
- Familiar with the country/regional standards and specifications;
- Knowledge of and compliance with this manual and other related documents.

Intended Use

- The Energy Meter is designed for indoor use only. It is a measuring device detecting the electrical values at the grid-connected point. It cannot be used for billing purposes. The data collected by the Energy Meter on the PV power generation may differ from the data of the main energy meter.
- Any use other than those described in this document does not qualify as appropriate usage and is prohibited. Do not make any modifications to the product.
- Damage or destruction may be caused to the Energy Meter due to inappropriate usage. The Energy Meter must not be operated beyond the values specified in the technical data.
- In case the phase current at the grid-connected point is $\leq 80\text{A}$, DTSD1352-C/10(80)A is recommended; and if the phase current is $> 80\text{A}$, DTSD1352-C/1(6)A is recommended.
- The following figure shows an application example of the Energy Meter DTSD1352-C/10(80)A in the PV system. The inverter figure is for your reference only.

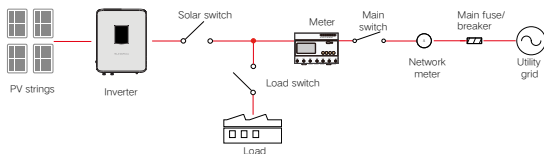

- The application of DTSD1352-C/1(6)A in the PV system requires the current transformer.

DANGER

Lethal voltages and danger to life due to electric shock!

- Only use the Energy Meter in a dry environment and keep it away from liquids.
- Install the Energy Meter in the switch cabinet only and ensure that the connection areas for the line and neutral conductors are behind an insulating cover or have contact protection.
- Install an external disconnect switch between the Energy Meter and the grid-connected point. The external disconnect must be close to the Energy Meter and easily accessible.
- Disconnect the Energy Meter from voltage sources before cleaning. The Energy Meter must be cleaned with a dry cloth only.

⚠ WARNING

Fire hazard!

- If a fuse is missing or incorrect, a fire may be caused when a fault occurs. This can result in death or serious injury.
- Protect the line conductors of the Energy Meter with a fuse or a main/selective circuit breaker switch, max. 80A.

Technical Data

Parameters	DTSD1352-C/10(80)A	DTSD1352-C/1(6)A
Nominal voltage	3 × 230/400V	
Voltage measurement range	3 × 180/311V ... 3 × 268/464V	
Input current	3 × 10(80)A	3 × 1(6)A (via CTs)
Grid frequency	50Hz	
Relative temperature	-25°C ... +55°C	
Relative humidity	≤95%(No condensation)	
Dimensions (W x H x D)	127 x 70 x 89 (mm)	

1 Delivery Contents

Related components in the scope of delivery:

- Energy Meter
- Quick installation guide

Three-phase energy meter and its terminals:

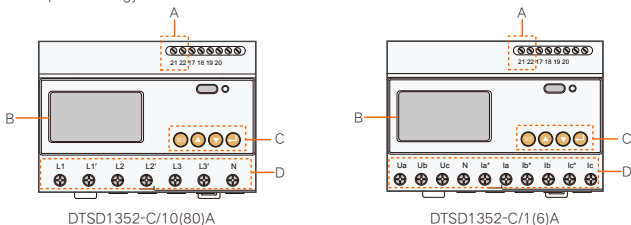

Designation	Description
A 21, 22	Communication terminals
B LCD display	Displays active energy and reactive energy, etc.
C Key	Includes set key, up key, down key, enter key
D Voltage and current terminals	-

2 Installation

Mount the Energy Meter to the 35 mm DIN rail. Hook it into the top edge of the rail and press down until it snaps into place.

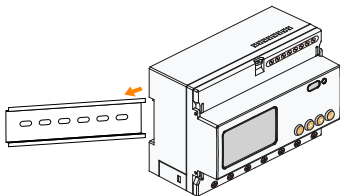

3 Cable Connection

Prepare the RS485 communication cable and three appropriate current transformers before connecting the energy meter DTSD1352-C/1(6)A. Connecting the DTSD1352-C/10(80)A does not require the current transformer. The communication cable is included in the delivery scope of some inverter or energy meter, for which consult the specific dealer.

The measurement range (primary current) of the current transformer should be selected according to actual maximum current at the grid-connected point, and the maximum secondary current of the current transformer should be 5A.

NOTICE

RS485 communication cables should be:

- Shielded twisted pair or Shielded Ethernet cables.
- Applicable to outdoor installation.

- Step 1 Turn off solar switch, load switch, main switch and other power switches, and secure them against reconnection.
- Step 2 Strip the insulation from the power cables by 10 mm, and then connect the cables to the terminals on the Energy Meter. (Cross-section: 10 mm² to 25 mm²)

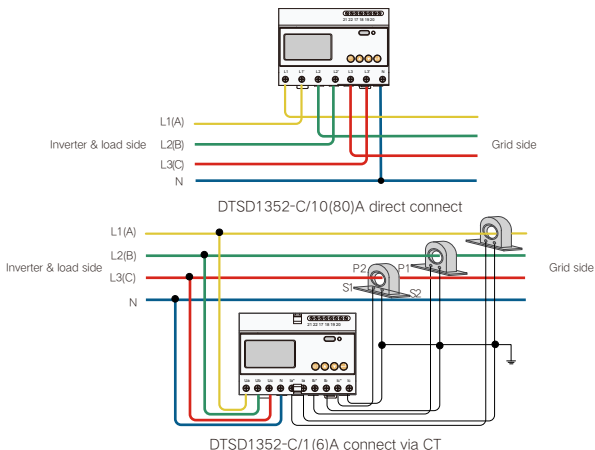

During connecting to the current transformers, note that:

- P1 side is connected to the grid, and P2 side is connected to the load.
- S1 terminals of the three current transformers are connected to Ia*, Ib*, and Ic* of the energy meter respectively; and S2 terminals are connected to Ia, Ib, and Ic respectively.
- S2 terminals of the three current transformers are connected together and then single-point grounded, for example, connected to the PE cable of the switch cabinet.

⚠ NOTICE

- Pay attention to the direction marks on the current transformer and avoid incorrect connection.
- The three-phase voltage sequence is consistent with the three-phase voltage sequence of the inverter. Ua, Ub, and Uc are corresponding to L1, L2, and L3 of the inverter respectively. Ensure correct cable connection.
- During routine maintenance, particularly pay attention to the connection terminals of the energy meter to prevent loose cable connection or open circuit. Otherwise, lethal high voltage will be generated on the secondary side of the current transformer.
- Just connect the line conductor L1, L1' and the neutral conductor, then the three-phase Energy Meter DTSD1352-C/10(80)A can be used as a single-phase meter.

- Step 3 Strip the insulation layer of the communication cable with a wire stripper, and lead the corresponding RS485A/B signal cable out. Insert cord end terminals into signal cable RS485+ A and signal cable RS485- B, and crimp them with a crimper. Cut off the redundant signal cable and wrap it with a heat-shrink tubing.
- If the communication cable is Shielded Ethernet cable, white-green cable 3 is defined as RS485- B cable and the green cable 6 as RS485+ A cable.

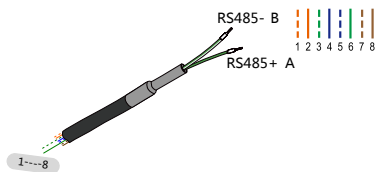

Corresponding Relationship Between Cables and Color :

Cable 1: White -orange ; Cable 2: Orange ;
Cable 3: White -green ; Cable 4: Blue ;
Cable 5: White -blue ; Cable 6: Green ;
Cable 7: White -brown ; Cable 8: Brown .

Cable 3 and Cable 6 are used for communication
- Cable 3 to RS 485 - B
- Cable 6 to RS 485+ A

i NOTE

- Skip performing step 3 when the communication cable is included in the scope of delivery.

- Step 4 Connect the plugs RS485+ A and RS485- B to terminals 21 and 22 on the Energy Meter.

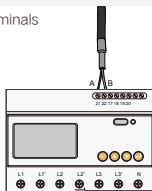

- Step 5 Connect the other end of the communication cable to the inverter, and reference can be made to the inverter user manual.
- Step 6 Cover the Energy Meter with the insulating cover or contact protection of the switch cabinet. Switch on the solar switch, load switch, main switch and other power switches.